

## Powder Dosing Solutions





# About Us

Transvac Systems Limited is a privately owned Ejector Solutions provider formed in 1973.

As both a designer and a manufacturer of Ejectors, Transvac has full in-house control over process and mechanical design, supply of raw materials, manufacturing, scheduling and testing. With all of our procedures certified to BS EN ISO 9001:2015 the quality of the final product is assured.

Transvac is accredited to Module H of the Annexe III Pressure Equipment Directive (PED) and our products are CE marked where appropriate. We are also 1st Point Assessment (FPAL), UVDB and Achilles registered.

All products are custom designed to suit the process and mechanical requirements of each application to ensure maximum operating efficiency.

Transvac offers standard and exotic materials of construction including Hastelloy, Duplex, Super Duplex, Titanium etc.





# Powder Dosing

Transvac liquid jet solids pumps provide a reliable and clean method of mixing, dosing and transferring solids using a liquid motive.

Liquid jet solids pumps can be used for an extensive range of materials including salt, sugar, yeast, lime, powdered carbon, sand, sawdust and many more.

Transvac can provide a tailor made turnkey system designed to fit your site requirements with a variety of configurations available.

## Configurations

Once-through or batch operation	✓
Standard or hygienic finish	✓
Fixed on a skid	✓
Packaged system	✓
Containerised system	✓
Manually fed from sacks	✓
Screw fed from a bulk bag system	✓
Screw fed from a silo	✓

## Advantages

No moving parts	✓
Simple & robust	✓
Custom designed	✓
Suitable for CIP	✓
Solids added at ground level	✓
In-line mixing	✓

## Materials

Carbon steel	✓
Stainless steel	✓
PVCu / PP	✓
Ceramic	✓
Exotics	✓

## Recent Clients



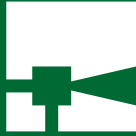

# Liquid Jet Solids Pumps

Transvac Liquid Jet Solids Pumps provide a versatile method of entraining solids, mixing them with the motive liquid and pumping the resulting mixture.

## Skid Package Systems

- ▶ Automatic controls (or manual)
- ▶ Duty/standby pump system
- ▶ 'Plug & Play' installation
- ▶ Hygienic polished finish
- ▶ Compatible with bulk-bag or silo systems
- ▶ For PAC dosing or other powders

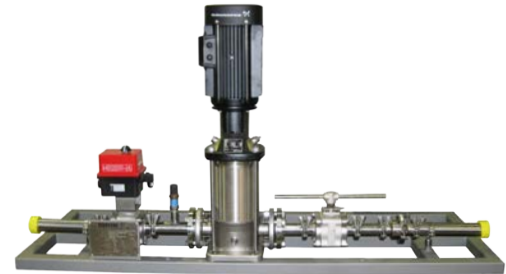

DUTY PUMP SKID FOR SCOTTISH WATER

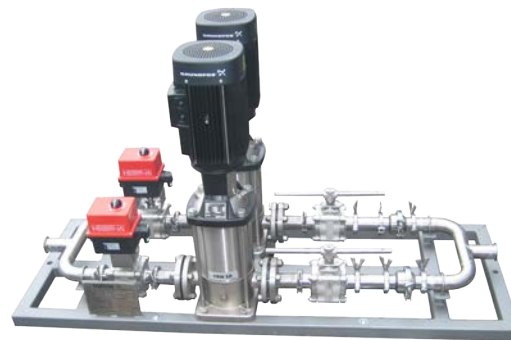

DUTY STANDBY PUMP SKID FOR UNITED UTILITIES



SKID PAC DOSING SYSTEM FOR YORKSHIRE WATER

## Dust Minimising Manual Feed Packages

- ▶ With enclosed hood to minimise dust exposure
- ▶ Compatible with 25kg bags
- ▶ Dosing PAC or other powders (potentially harmful)
- ▶ Hygienic polished finish
- ▶ Available as mobile systems
- ▶ Used for a water purification system



HYGIENIC MANUAL BAG FEED - BAXTERS HEALTHCARE



## Hygienic Solids Addition

Our Hygienic hoppers can be used for many types of powder addition including maltodextrin, salt and powdered yeast and are often used within the pharmaceutical and food industries. Our venturi type Ejectors use a motive liquid to entrain the solid particles and transfer it down process pipework and into tanks. The specialist design induces high levels of mixing which can aid the formation of solutions. Our units are also laid out to minimise any chances of blockage.

- ▶ Manual dosing
- ▶ Support shelf for bags
- ▶ Hygienic polished finish
- ▶ Washdown built in
- ▶ Quick and easy to install
- ▶ Tri-clamp connections available
- ▶ CIP Applications

Suitable for:

- ▶ Maltodextrin
- ▶ Sodium Chloride
- ▶ Potassium Chloride
- ▶ Magnesium Chloride
- ▶ Calcium Chloride
- ▶ Glacial Acetic Acid
- ▶ Powdered Yeast

All of the below are available in a variety of configurations





# Lime Dosing

Stainless Steel system with 50l capacity hopper capable of accepting a large dosing range of powder from a metering screw or manual addition

- ▶ Suitable for silo or bulk-bag systems
- ▶ Washdown
- ▶ Removable internals for cleaning
- ▶ Polished finish
- ▶ Accurate dosing
- ▶ No moving parts



# Bulk Bag Systems

Installed inside an existing building to dose powders or granules to a Transvac hopper and Ejector system

- ▶ Winch included
- ▶ Accurate dosing
- ▶ Hygienic design possible
- ▶ Variable dose rate
- ▶ Booster pump included



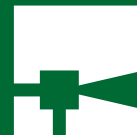

# Resin Loading Systems

These systems have been supplied to nuclear and water industries for transfer of Ion Exchange resin into packed towers for water purification and softening. The motive liquid fluidises the resin beads and the Ejector provides lift to transport the resin into the exchange columns.

- ▶ Polypropylene or Stainless Steel
- ▶ Mobile/fixed systems
- ▶ Flexible or fixed washdown
- ▶ Ideal for batch dosing
- ▶ Suitable for hazardous areas
- ▶ Quick & easy installation
- ▶ Manufactured to ASME, NORSOK etc. standards



# Sawdust Addition

Motive liquid is used to entrain sawdust and transfer it as a slurry into condenser tubes where it is used to plug holes and stop leaks

- ▶ Mobile arrangement
- ▶ Available in Carbon Steel/Stainless Steel
- ▶ Including flexible washdown
- ▶ Pressure gauge on inlet



# Sand Slurry Transfer

Robust hopper designed to transfer sand slurry using motive liquid and hard wearing internals

- ▶ Ceramic nozzle and diffuser to cope with highly abrasive materials
- ▶ Including flexible washdown
- ▶ Manufactured to ASME, NORSOK etc. standards

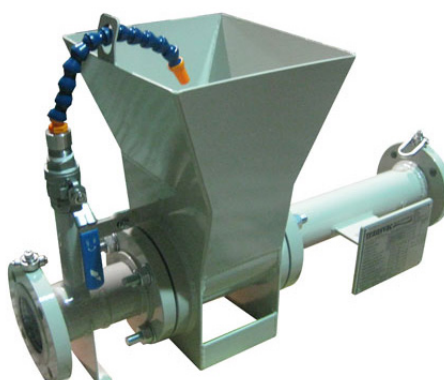

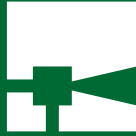

# TransPAC - a complete PAC dosing solution



## Acting fast

When water standards slip, you need to act fast. The TransPAC dosing solution puts you back in control.

With minimal need for building or groundworks, TransPAC provides a safe and secure home for your dosing solution. Simply hook it up and away you go.

TransPAC provides once-through inline dosing, so there are no batch mixing tanks to contend with and the fully programmable HMI control panel provides accurate and efficient dosing. After all, no one likes wastage.

The TransPAC is also supplied with a silo adapter kit which can be easily fitted by the site operator to enable the system to receive carbon from a site silo, rather than a bulk bag.

## A Containerised **TransPAC** Dosing System Includes

Secure, vandal-proof container with lighting	✓
Transvac PAC Ejector, in-line wet mixing / pumping system	✓
Flexicon powder handling / metering system (bulk bag or silo fed option)	✓
Clean water, pressure booster pumps	✓
Water header tank	✓
Site specific control panel with alarm interface	✓
Interconnecting pipework and valves (manual or automated)	✓
Instrumentation	✓
Optional compressor	✓
Silo feed adapter kit	✓
Dust extraction system	✓

For more detailed information on TransPAC, see our TransPAC brochure or visit [www.carbondosing.com](http://www.carbondosing.com)



The silo feed adapter kit makes the system flexible to your site requirements and provides ultimate flexibility



# Advantages of a **TransPAC** Dosing System

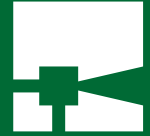

PAC dose rate to match works flow	✓
Accurate dosing, no PAC wastage	✓
Clean and reliable operation	✓
Once through in-line mixing	✓
Dosing lines flushed clean after use	✓
No wet mixing moving parts	✓
Minimal maintenance	✓
Simple to install and operate, minimal civil works required	✓
Hygienic design	✓
Manual or fully automatic operation	✓
Compatible with site telemetry	✓
Containers can be moved from site to site as required	✓
No requirement to involve M & E Contractors	✓

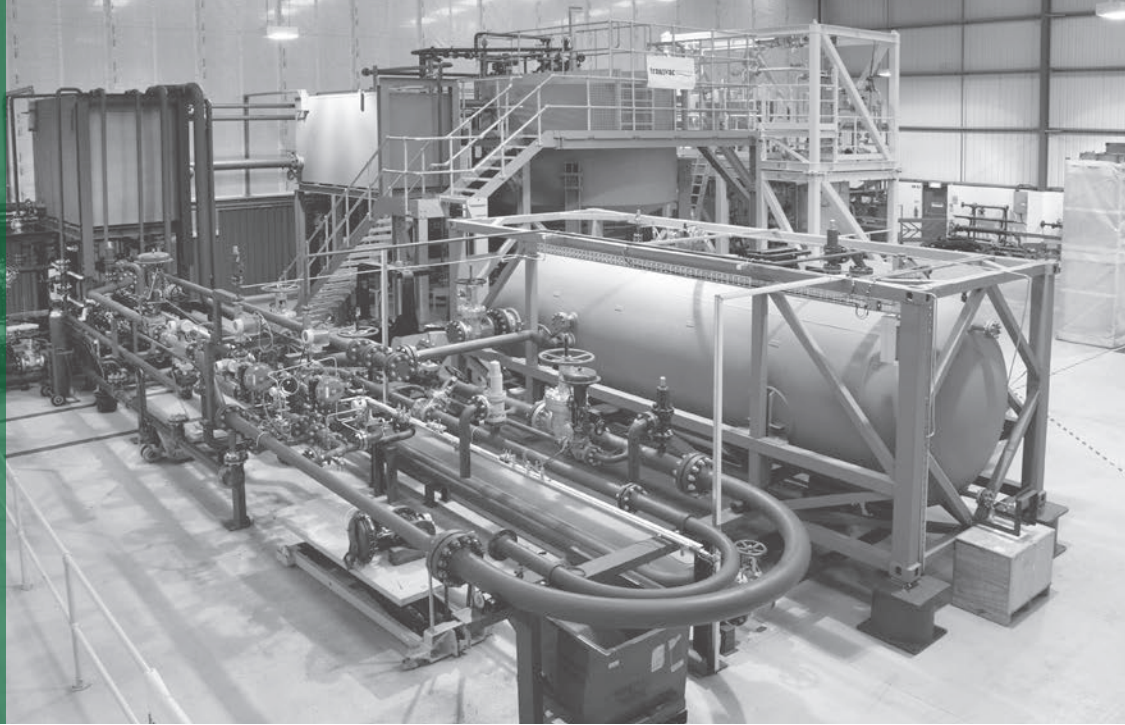

## Research & Development Test Facility

Transvac officially opened its R&D Test facility in April 2010. The state-of-the-art test facility primarily develops new oil & gas Ejector technology for subsea processing, flare gas recovery, sand slurry pumping and production boosting.

Ejector applications for the nuclear, bio-fuel, chemical and wastewater industries are also under development.

The R&D test facility includes high and low pressure equipment for handling water, gas, multi-phase and

slurry. Test programmes are supported by CFD studies and include fundamental University research.

The Transvac facilities include liquid flow lines for high, medium & low pressure testing (in excess of 250 bar (g)) and solids handling systems.

Transvac performs functional validation tests for Ejectors used in the oil & gas, nuclear and process industries.

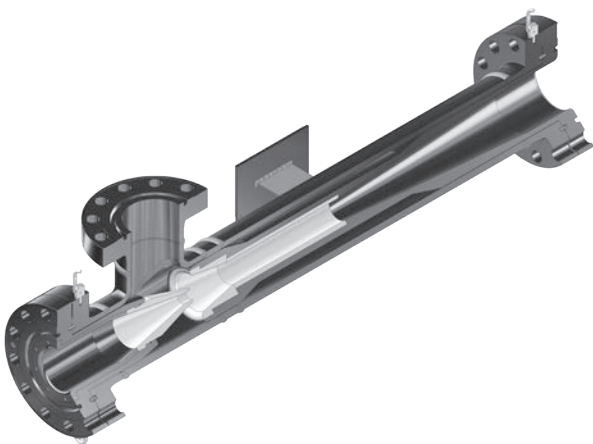

*Why not visit Transvac head office and take a tour of the first-class R&D facility for yourself?*



# Research & Development - Key Research Areas

## Fluid Structure Interaction

- ▶ Jet break up characterisation
- ▶ Coalescing and dispersion of multiphase flows
- ▶ Measurement techniques [laser Doppler]
- ▶ CFD model calibration [new code development]

## High Motive Pressure Liquid Jet Compressor

- ▶ Optimisation & characterisation
- ▶ Scaled trials
- ▶ CFD model calibration

Recent R&D clients:



## Low energy inline micro bubble generation

- ▶ Optimisation of new equipment and envelope testing

## Gas Motivate Liquid Units

- ▶ Optimisation and stabilisation studies

## Liquid Jet Pump Erosion Prediction Techniques

- ▶ Micro scale experimental trials
- ▶ CFD modelling and calibration
- ▶ Full scale Ejector testing
- ▶ Accelerated testing methods

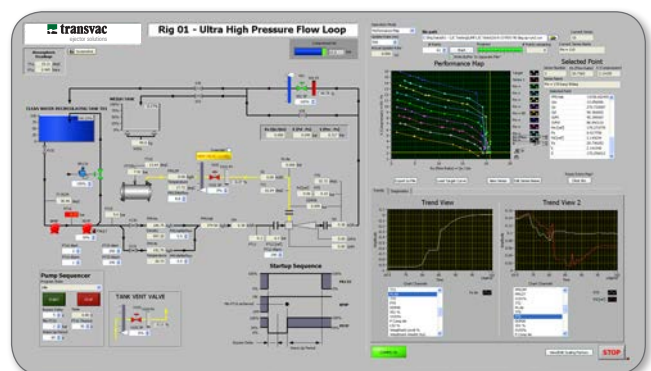



Transvac Systems Ltd., Monsal House, 1 Bramble Way, Alfreton, Derbyshire, DE55 4RH, UK  
**Tel:** +44 (0) 1773 831100 | **Email:** sales@transvac.co.uk | **Web:** www.transvac.co.uk

Registered in England No. 1526398

[www.carbondosing.com](http://www.carbondosing.com)

